

**PRO**  
PROFESSIONAL  
LED

"The best is yet to Light"



**Industrial**

**JISO**  
ILUMINACION  
SPAIN

INDUSTRIAL



JISO  
INDUSTRIAL  
SPAIN



## Waterproof Screen

Light Integrated LED P.421

600mm



00418-16 P.421 00418-D9 P.427  
Dimm DALI/PUSH

1200 mm



00436-16 P.423 00436-D9 P.428 00436-86 P.431  
Dimm DALI/PUSH Emergency kit

1500 mm



00450-16 P.425 00450-D9 P.429  
Dimm DALI/PUSH

Light Without Technology P.433



04120D P.433 04120DD P.435 04150D P.436 04150DD P.437



## 00418

Pantalla Estanca LED  
LED Waterproof Screen  
Panneau LED Étanche

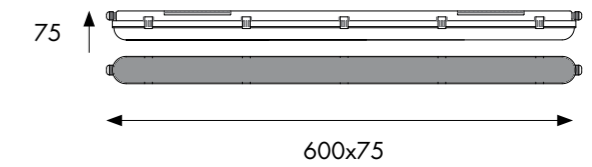

### Continuous connection



## 004 18 - 16 8 4 - 90

1 - Model	2 - W	3 - Driver	4 - Brand Chip	5 - K	6 - Color
004	18	16 - ON-OFF AC220-240V PF >0,95  D9 - DALI/PUSH AC220-240V PF >0,95	8 - Sanan	4 - 4000 2344 Lm System 2520 Lm Source	90 T. White / Blanco T. / Blanc T.

Diametro de cable Ø 8 / 12 mm  
Medida cable 1,5mm2  
Cable diabeter Ø 8 / 12 mm  
Cable size 1,5mm2  
Diamètre de câble Ø 8 / 12 mm  
Mesure de câble 1,5mm2

LED CHIP: SMD 2835 - CRI>80 - L70B10 / 50.000H - 140lm/W (4000K) - RG1



The above information is basic. For updated and more accurate information, please consult Technical Data Sheet on [www.jisoiluminacion.com](http://www.jisoiluminacion.com)  
Consult general issues - [www.jisoiluminacion.com](http://www.jisoiluminacion.com) (Download - Technical Information)

# I Features Waterproof Screen



## New Desing

Our waterproof screen 004 offers an efficient and safe solution for lighting spaces with high humidity or exposure to water. Its new design allows for easy installation on flat surfaces, such as ceilings, and adapts to different environments, both indoors and outdoors. This is a **high quality luminaire** offering professional performance. **High efficiency and high light package.** It is **guaranteed for 5 years** and can be **dimmed** via **DALI** or **1-10V**. It is ideal for projects that require flexibility and efficiency.



## Technical improvements

Continuous connection  
**Extra cap** included  
**Stainless Steel Clips**  
The **plug** and **caps** included are for double sides or rear entry

## Continuous connection

A feature of our watertight screens is that they allow the continuous connection of one screen to another thanks to their **double sides and set included.**



## Security

Our watertight screens have a **safety cable** that holds the two parts of the luminaire together for easy installation.



## 00436

Pantalla Estanca LED  
LED Waterproof Screen  
Panneau LED Étanche

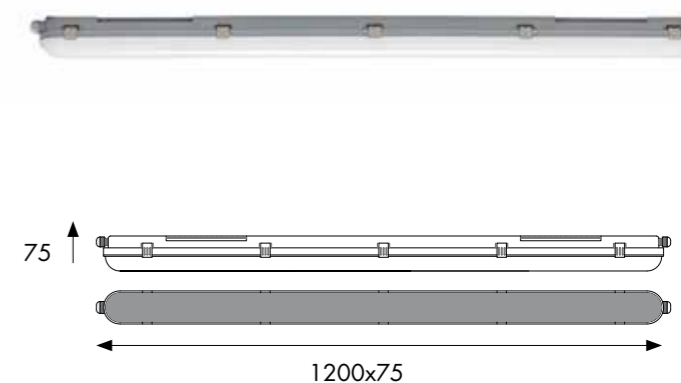

## Continuous connection



Ref.	Wattios	Unit in continous
00436	36	≤30*

## 004 36 - 16 8 4 - 90

1 - Model	2 - W	3 - Driver	4 - Brand Chip	5 - K	6 - Color
004	36	16 - ON-OFF AC220-240V PF >0,95 D9 - DALI/PUSH AC220-240V PF >0,95	8 - Sanan	4 - 4000 4735 Lm System 5040 Lm Source 6 - 6500 4972 Lm System 5040 Lm Source	90 T. White / Blanco T. / Blanc T.

Diametro de cable Ø 8 / 12 mm  
Medida cable 1,5mm2  
Cable diabeter Ø 8 / 12 mm  
Cable size 1,5mm2  
Diamètre de câble Ø 8 / 12 mm  
Mesure de câble 1,5mm2

LED CHIP: SMD 2835 - CRI>80 - L70B10 / 50.000H - 140lm/W (4000K) - RG1



The above information is basic. For updated and more accurate information, please consult Technical Data Sheet on [www.jisoiluminacion.com](http://www.jisoiluminacion.com)  
Consult general issues - [www.jisoiluminacion.com](http://www.jisoiluminacion.com) (Download - Technical Information)

## 00450

Pantalla Estanca LED  
LED Waterproof Screen  
Panneau LED Étanche

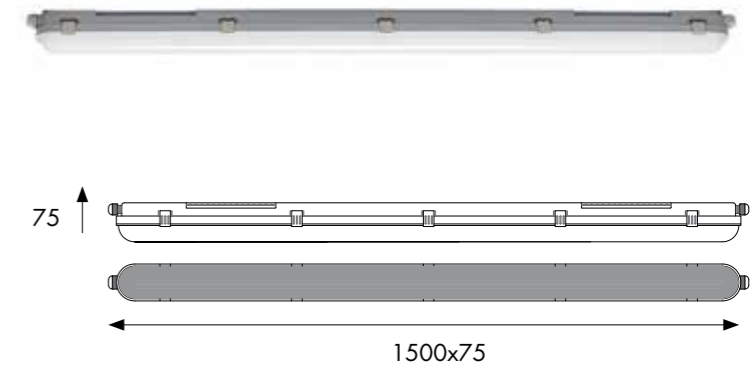

## I Features Waterproof Screen



### New Desing

Our waterproof screen 004 offers an efficient and safe solution for lighting spaces with high humidity or exposure to water. Its new design allows for easy installation on flat surfaces, such as ceilings, and adapts to different environments, both indoors and outdoors. This is a **high quality luminaire** offering professional performance. **High efficiency** and **high light package**. It is **guaranteed for 5 years** and can be **dimmed** via **DALI** or **1-10V**. It is ideal for projects that require flexibility and efficiency.



### Technical improvements

Continuous connection  
**Extra cap** included  
**Stainless Steel Clips**  
The **plug** and **caps** included are for double sides or rear entry

### Continuous connection

A feature of our watertight screens is that they allow the continuous connection of one screen to another thanks to their **double sides and set included**.



### Security

Our watertight screens have a **safety cable** that holds the two parts of the luminaire together for easy installation.

### Continuous connection



Ref.	Wattios	Unit in continous
00450	50	≤20*

## 004 50 - 16 8 4 - 90

1 - Model	2 - W	3 - Driver	4 - Brand Chip	5 - K	6 - Color
004	50	<p>⏻ 16 - ON-OFF AC220-240V PF &gt;0,95</p> <p>⚡ D9 - DALI/PUSH AC220-240V PF &gt;0,95</p>	8 - Sanan	<p>4 - ■ 4000 6562 Lm System 7000 Lm Source</p> <p>6 - ■ 6500 6890 Lm System 7000 Lm Source</p>	90 T. White / Blanco T. / Blanc T.

Diametro de cable Ø 8 /12 mm  
Medida cable 1,5mm2  
Cable diabeter Ø 8 /12 mm  
Cable size 1,5mm2  
Diamètre de câble Ø 8 /12 mm  
Mesure de câble 1,5mm2

LED CHIP: SMD 2835 - CRI>80 - L70B10 / 50.000H - 140lm/W (4000K) - RG1



The above information is basic. For updated and more accurate information, please consult Technical Data Sheet on [www.jisoiluminacion.com](http://www.jisoiluminacion.com)  
Consult general issues - [www.jisoiluminacion.com](http://www.jisoiluminacion.com) (Download - Technical Information)

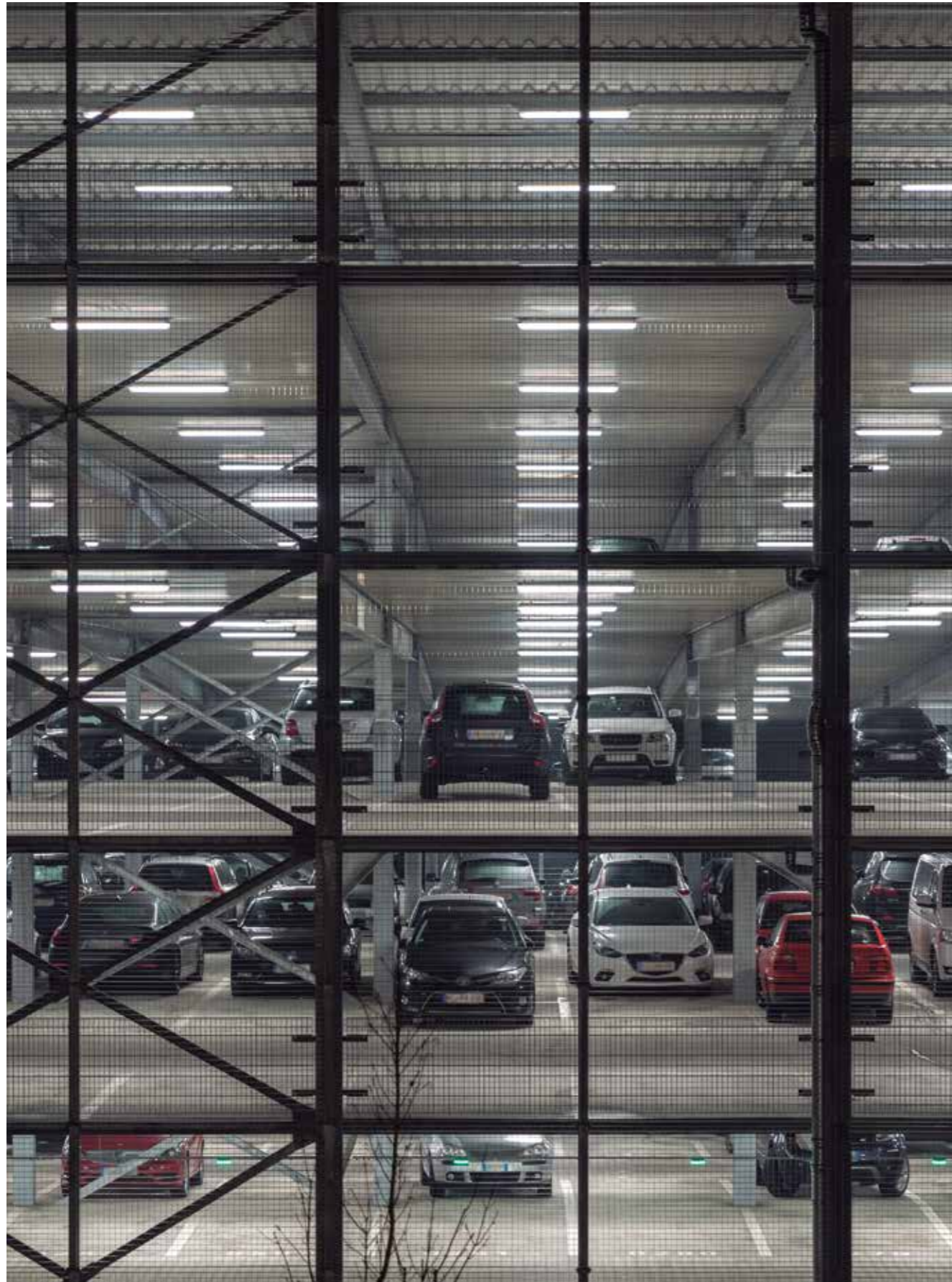

00418-D9

Pantalla Estanca LED  
LED Waterproof Screen  
Panneau LED Étanche

**NEW**  
Dimmable  
DALI/PUSH

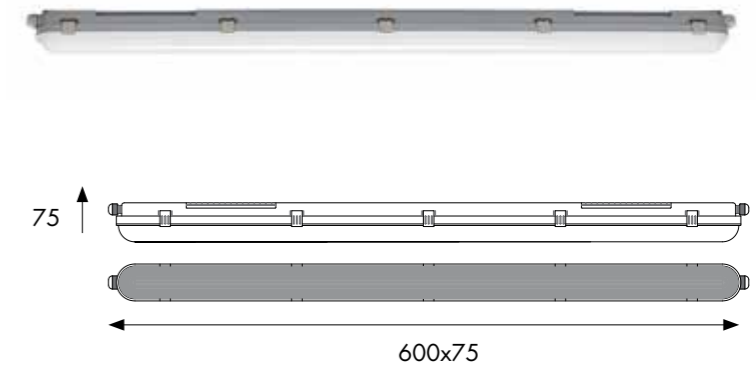

Double sides



Security



Stainless Steel Clips

004 18 - D9 8 4 - 90

1 - Model	2 - W	3 - Driver	4 - Brand Chip	5 - K	6 - Color
004	18	D9 - DALI/PUSH AC220-240V PF >0,95	8 - Sanan	4 - 4000 2344 Lm System 2520 Lm Source	90 T. White / Blanco T. / Blanc T.

Diametro de cable Ø 8 /12 mm  
Medida cable 1,5mm2  
Cable diabeter Ø 8 /12 mm  
Cable size 1,5mm2  
Diamètre de câble Ø 8 /12 mm  
Mesure de câble 1,5mm2

LED CHIP: SMD 2835 - CRI>80 - L70B10 / 50.000H - 140lm/W (4000K) - RG1



The above information is basic. For updated and more accurate information, please consult Technical Data Sheet on [www.jisoiluminacion.com](http://www.jisoiluminacion.com)  
Consult general issues - [www.jisoiluminacion.com](http://www.jisoiluminacion.com) (Download - Technical Information)



00436-D9

Pantalla Estanca LED  
LED Waterproof Screen  
Panneau LED Étanche

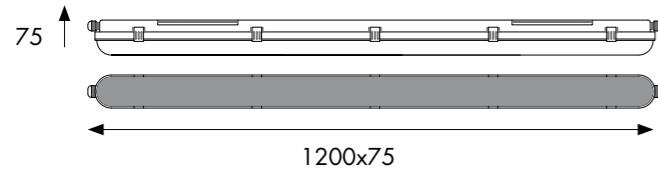

00450-D9

Pantalla Estanca LED  
LED Waterproof Screen  
Panneau LED Étanche

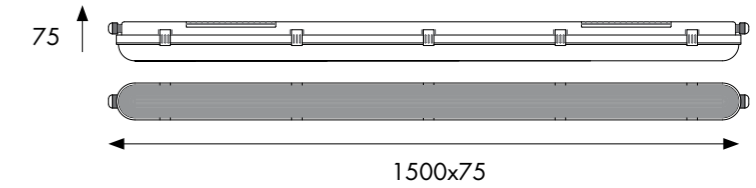

**NEW**  
Dimmable  
DALI/PUSH

**NEW**  
Dimmable  
DALI/PUSH

004 36 - D9 8 4 - 90

1 - Model	2 - W	3 - Driver	4 - Brand Chip	5 - K	6 - Color
004	36	D9 - DALI/PUSH AC220-240V PF >0,95	8 - Sanan	4 - 4000 4735 Lm System 5040 Lm Source 6 - 6500 4972 Lm System 5040 Lm Source	90 T. White / Blanco T. / Blanc T.

Diametro de cable Ø 8 /12 mm  
Medida cable 1,5mm2  
Cable diabeter Ø 8 /12 mm  
Cable size 1,5mm2  
Diamètre de câble Ø 8 /12 mm  
Mesure de câble 1,5mm2

LED CHIP: SMD 2835 - CRI>80 - L70B10 / 50.000H - 140lm/W (4000K) - RG1



The above information is basic. For updated and more accurate information, please consult Technical Data Sheet on [www.jisoiluminacion.com](http://www.jisoiluminacion.com)  
Consult general issues - [www.jisoiluminacion.com](http://www.jisoiluminacion.com) (Download - Technical Information)

004 50 - D9 8 4 - 90

1 - Model	2 - W	3 - Driver	4 - Brand Chip	5 - K	6 - Color
004	50	D9 - DALI/PUSH AC220-240V PF >0,95	8 - Sanan	4 - 4000 6562 Lm System 7000 Lm Source 6 - 6500 6890 Lm System 7000 Lm Source	90 T. White / Blanco T. / Blanc T.

Diametro de cable Ø 8 /12 mm  
Medida cable 1,5mm2  
Cable diabeter Ø 8 /12 mm  
Cable size 1,5mm2  
Diamètre de câble Ø 8 /12 mm  
Mesure de câble 1,5mm2

LED CHIP: SMD 2835 - CRI>80 - L70B10 / 50.000H - 140lm/W (4000K) - RG1



The above information is basic. For updated and more accurate information, please consult Technical Data Sheet on [www.jisoiluminacion.com](http://www.jisoiluminacion.com)  
Consult general issues - [www.jisoiluminacion.com](http://www.jisoiluminacion.com) (Download - Technical Information)





00436-86

Pantalla Estanca LED  
LED Waterproof Screen  
Panneau LED Étanche

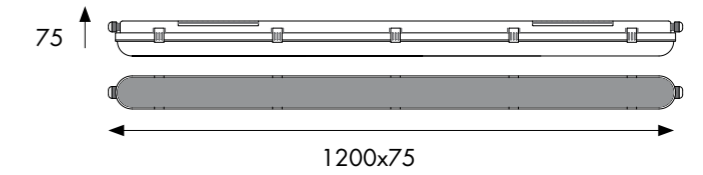

Continuous connection

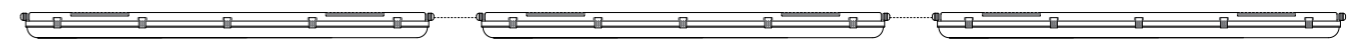

▼ Included Emergency Kit. 3h auto.

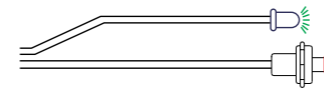

LED Indicator  
Test Switch

004 36 - 86 8 4 - 90

1 - Model	2 - W	3 - Driver	4 - Brand Chip	5 - K	6 - Color
004	36	86 - ON-OFF AC220-240V PF >0,9	8 - Sanan	4 - 4000 4735 Lm System 5040 Lm Source	90 T. White / Blanco T. / Blanc T.

Diametro de cable Ø 8 / 12 mm  
Medida cable 1,5mm2  
Cable diabeter Ø 8 / 12 mm  
Cable size 1,5mm2  
Diamètre de câble Ø 8 / 12 mm  
Mesure de câble 1,5mm2

LED CHIP: SMD 2835 - CRI>80 - L70B10 / 50.000H - 140lm/W (4000K) - RG1



The above information is basic. For updated and more accurate information, please consult Technical Data Sheet on [www.jisoiluminacion.com](http://www.jisoiluminacion.com)  
Consult general issues - [www.jisoiluminacion.com](http://www.jisoiluminacion.com) (Download - Technical Information)

# | Waterproof Screen Empty



Screen for 1 LED tube. Ref 04120D & 04150D  
Pantalla para 1 tubo LED. Ref 04120D & 04150D



Screen for 2 LED tube. Ref 04120DD & 04150DD  
Pantalla para 2 tubo LED. Ref 04120DD & 04150DD



## 04120D

Pantalla Estanca Vacía para 1 Tubo LED  
Empty Waterproof Screen for 1 LED Tube  
Panneau Étanche Vide pour 1 tube LED

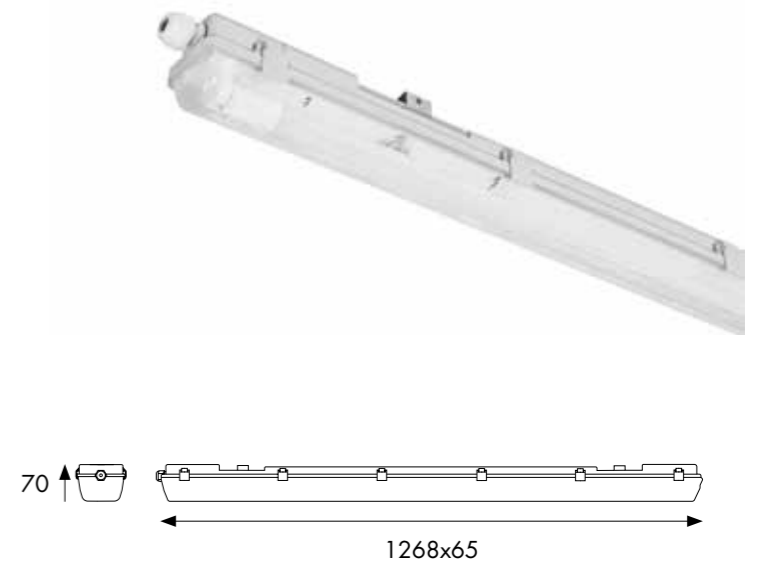

## 04120D - 90

1 - Model	5 - Color
04120D	90 Tec. White / Blanco Téc. / Blanc Tech.

▼ Accessories not included

Metal Clip  
DC04120-05 (set 12 pcs.)

► Plastic clip & pack presaestopa included



The above information is basic. For updated and more accurate information, please consult Technical Data Sheet on [www.jisoiluminacion.com](http://www.jisoiluminacion.com)  
Consult general issues - [www.jisoiluminacion.com](http://www.jisoiluminacion.com) (Download - Technical Information)



04120DD

Pantalla Estanca Vacía para 2 Tubo LED  
 Empty Waterproof Screen for 2 LED Tube  
 Panneau Étanche Vide pour 2 tube LED

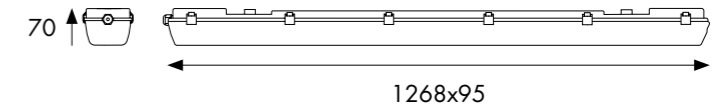

04120DD - 90

1 - Model	5 - Color
04120DD	90 Tec. White / Blanco Téc. / Blanc Tech.

▼ Accessories not included

Metal Clip  
 DC04120-05 (set 12 pcs.)

► Plastic clip & pack presaestopa included



The above information is basic. For updated and more accurate information, please consult Technical Data Sheet on [www.jisoiluminacion.com](http://www.jisoiluminacion.com)  
 Consult general issues - [www.jisoiluminacion.com](http://www.jisoiluminacion.com) (Download - Technical Information)

04150D

Pantalla Estanca Vacía para 1 Tubo LED  
Empty Waterproof Screen for 1 LED Tube  
Panneau Étanche Vide pour 1 tube LED

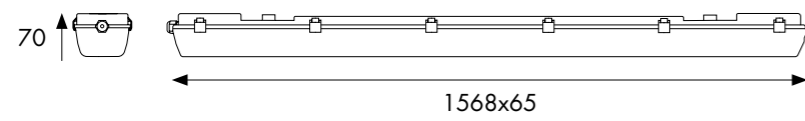

04150DD

Pantalla Estanca Vacía para 2 Tubo LED  
Empty Waterproof Screen for 2 LED Tube  
Panneau Étanche Vide pour 2 tube LED

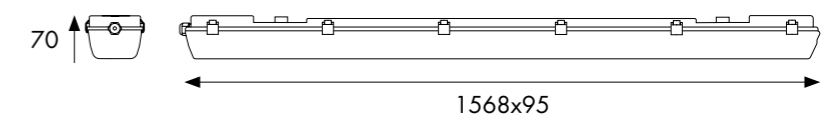

04150D - 90

1 - Model	5 - Color
04150D	90 Tec. White / Blanco Téc. / Blanc Tech.

► Plastic clip & pack presaestopa included



The above information is basic. For updated and more accurate information, please consult Technical Data Sheet on [www.jisoiluminacion.com](http://www.jisoiluminacion.com)  
Consult general issues - [www.jisoiluminacion.com](http://www.jisoiluminacion.com) (Download - Technical Information)

▼ Accessories not included

Metal Clip
DC04150-05 (set 12 pcs.)



04150DD - 90

1 - Model	5 - Color
04150DD	90 Tec. White / Blanco Téc. / Blanc Tech.

► Plastic clip & pack presaestopa included



The above information is basic. For updated and more accurate information, please consult Technical Data Sheet on [www.jisoiluminacion.com](http://www.jisoiluminacion.com)  
Consult general issues - [www.jisoiluminacion.com](http://www.jisoiluminacion.com) (Download - Technical Information)

▼ Accessories not included

Metal Clip
DC04150-05 (set 12 pcs.)

## Flood Light IP65



00710 P.442



00720 P.443



00730 P.445



00750  
Sensor P.446



00750 P.447



07100 P.448



07150 P.449



07200 P.451

Available  Technical White/Blanco Técnico/Blanch Techniqué

Easy installation



Fast connection system

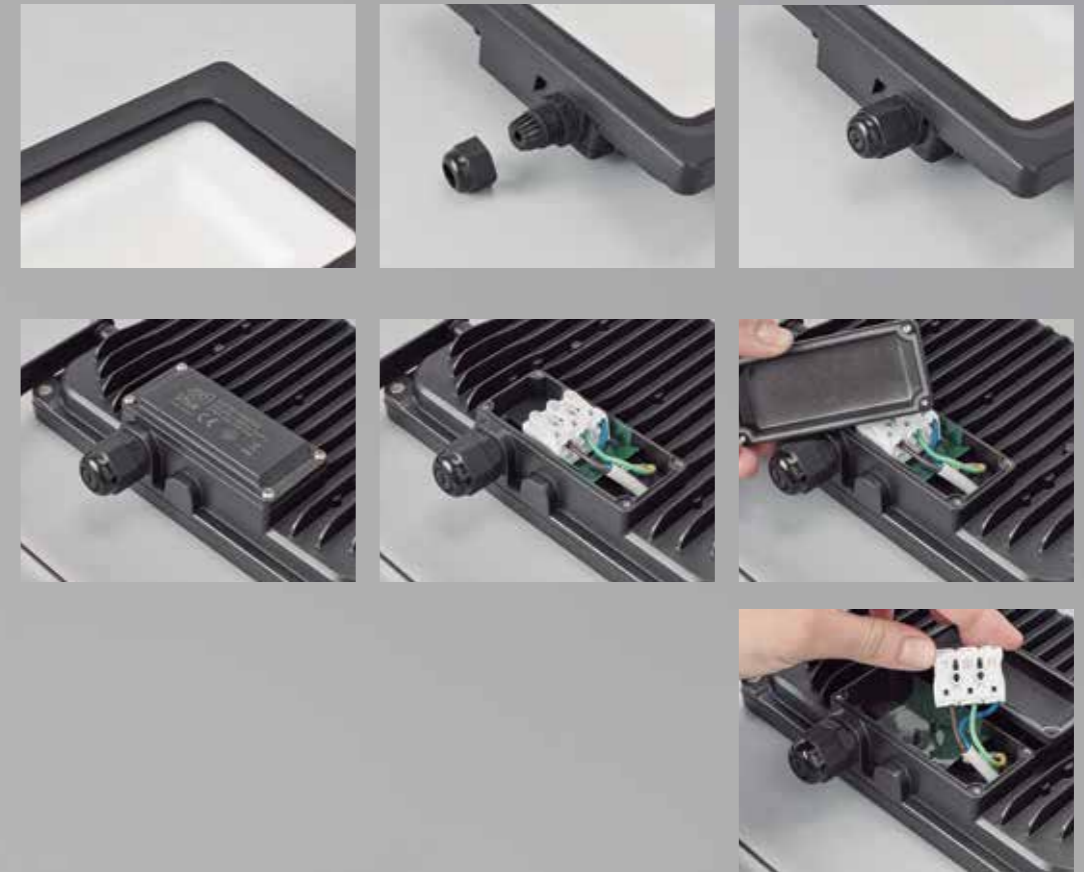

Wide range of finishes, measures & powers



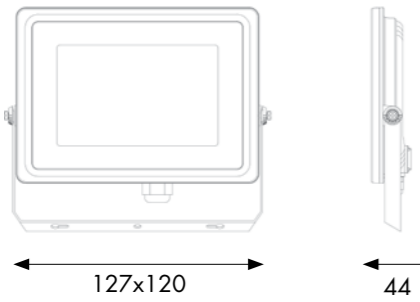

00710

Proyector Exterior LED  
LED Flood Light  
Projecteur Extérieur LED

00720

Proyector Exterior LED  
LED Flood Light  
Projecteur Extérieur LED

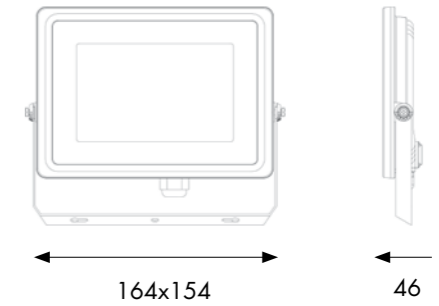

007 10 - 19 9 4 - 01

1 - Model	2 - W	3 - Driver	4 - Brand Chip	5 - K	6 - Color
007	10	19 - ON-OFF AC220-240V PF >0,9	9 - Smalite	4 - 4000 1010 Lm System 1250 Lm Source  6 - 6000 1060 Lm System 1313 Lm Source	01 Black / Negro / Noir

LED CHIP: SMD 2835 - CRI>80 - L70B10 / 35.000H - 125lm/W (4000K) - RG1



The above information is basic. For updated and more accurate information, please consult Technical Data Sheet on [www.jisoiluminacion.com](http://www.jisoiluminacion.com)  
Consult general issues - [www.jisoiluminacion.com](http://www.jisoiluminacion.com) (Download - Technical Information)

007 20 - 19 9 4 - 01

1 - Model	2 - W	3 - Driver	4 - Brand Chip	5 - K	6 - Color
007	20	19 - ON-OFF AC220-240V PF >0,9	9 - Smalite	4 - 4000 2074 Lm System 2500 Lm Source  6 - 6000 2177 Lm System 2625 Lm Source	01 Black / Negro / Noir

LED CHIP: SMD 2835 - CRI>80 - L70B10 / 35.000H - 125lm/W (4000K) - RG1



The above information is basic. For updated and more accurate information, please consult Technical Data Sheet on [www.jisoiluminacion.com](http://www.jisoiluminacion.com)  
Consult general issues - [www.jisoiluminacion.com](http://www.jisoiluminacion.com) (Download - Technical Information)



00730

Proyector Exterior LED  
LED Flood Light  
Projecteur Extérieur LED

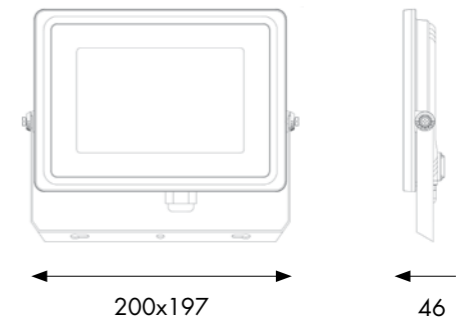

007 30 - 19 9 4 - 01

1 - Model	2 - W	3 - Driver	4 - Brand Chip	5 - K	6 - Color
007	30	19 - ON-OFF AC220-240V PF >0,9	9 - Smalite	4 - 4000 3069 Lm System 3750 Lm Source 6 - 6000 3222 Lm System 3938 Lm Source	01 Black / Negro / Noir Only in 4000K 90 T. White / Blanco T. / Blanc T.

LED CHIP: SMD 2835 - CRI>80 - L70B10 / 35.000H - 125lm/W (4000K) - RG1



The above information is basic. For updated and more accurate information, please consult Technical Data Sheet on [www.jisoiluminacion.com](http://www.jisoiluminacion.com)  
Consult general issues - [www.jisoiluminacion.com](http://www.jisoiluminacion.com) (Download - Technical Information)



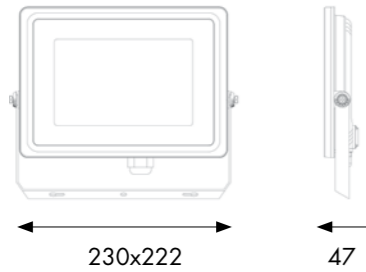

00750-99

Proyector Exterior LED Sensor  
LED Flood Light Sensor  
Projecteur Extérieur LED Sensor



00750

Proyector Exterior LED  
LED Flood Light  
Projecteur Extérieur LED

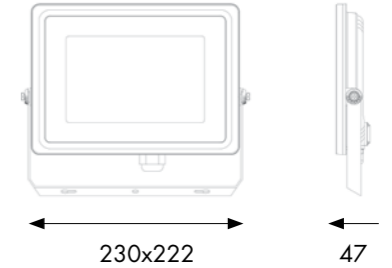

007 50 - 99 9 4 - 01

1 - Model	2 - W	3 - Driver	4 - Brand Chip	5 - K	6 - Color
007	50	99 - ON-OFF+SENSOR AC220-240V PF >0,9	9 - Smalite	4 - 4000 5094 Lm System 6250 Lm Source  6 - 6000 5348 Lm System 6563 Lm Source	01 Black / Negro / Noir  90 T. White / Blanco T. / Blanc T.

LED CHIP: SMD 2835 - CRI>80 - L70B10 / 35.000H - 125lm/W (4000K) - RG1



The above information is basic. For updated and more accurate information, please consult Technical Data Sheet on [www.jisoiluminacion.com](http://www.jisoiluminacion.com)  
Consult general issues - [www.jisoiluminacion.com](http://www.jisoiluminacion.com) (Download - Technical Information)

007 50 - 19 9 4 - 01

1 - Model	2 - W	3 - Driver	4 - Brand Chip	5 - K	6 - Color
007	50	19 - ON-OFF AC220-240V PF >0,9	9 - Smalite	2 - 2700K 4597 Lm System 5641 Lm Source  4 - 4000 5094 Lm System 6250 Lm Source  6 - 6000 5348 Lm System 6563 Lm Source	01 Black / Negro / Noir <i>Only in 2700K &amp; 4000K</i>  90 T. White / Blanco T. / Blanc T. <i>Only in 4000K &amp; 6000K</i>

LED CHIP: SMD 2835 - CRI>80 - L70B10 / 35.000H - 125lm/W (4000K) - RG1



The above information is basic. For updated and more accurate information, please consult Technical Data Sheet on [www.jisoiluminacion.com](http://www.jisoiluminacion.com)  
Consult general issues - [www.jisoiluminacion.com](http://www.jisoiluminacion.com) (Download - Technical Information)

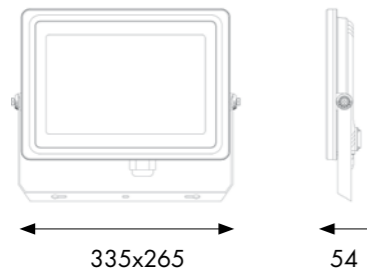

07100

Proyector Exterior LED  
LED Flood Light  
Projecteur Extérieur LED



07150

Proyector Exterior LED  
LED Flood Light  
Projecteur Extérieur LED

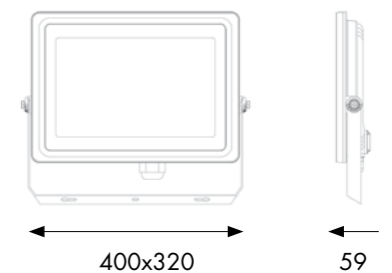

07 100 - 19 9 4 - 01

1 - Model	2 - W	3 - Driver	4 - Brand Chip	5 - K	6 - Color
07	100	19 - ON-OFF AC220-240V PF >0,9	9 - Smalite	4 - ■ 4000 10502 Lm System 12500 Lm Source 6 - ■ 6000 11027 Lm System 13125 Lm Source	01 Black / Negro / Noir

LED CHIP: SMD 2835 - CRI>80 - L70B10 / 30.000H - 125lm/W (4000K) - RG0



The above information is basic. For updated and more accurate information, please consult Technical Data Sheet on [www.jisoiluminacion.com](http://www.jisoiluminacion.com)  
Consult general issues - [www.jisoiluminacion.com](http://www.jisoiluminacion.com) (Download - Technical Information)

07 150 - 19 9 4 - 01

1 - Model	2 - W	3 - Driver	4 - Brand Chip	5 - K	6 - Color
07	150	19 - ON-OFF AC220-240V PF >0,9	9 - Smalite	4 - ■ 4000 16342 Lm System 18750 Lm Source 6 - ■ 6000 17158 Lm System 19688 Lm Source	01 Black / Negro / Noir

LED CHIP: SMD 2835 - CRI>80 - L70B10 / 30.000H - 125lm/W (4000K) - RG0



The above information is basic. For updated and more accurate information, please consult Technical Data Sheet on [www.jisoiluminacion.com](http://www.jisoiluminacion.com)  
Consult general issues - [www.jisoiluminacion.com](http://www.jisoiluminacion.com) (Download - Technical Information)

## 07200

Proyector Exterior LED  
LED Flood Light  
Projecteur Extérieur LED

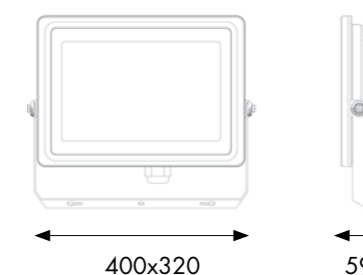

## 07 200 - 19 9 4 - 01

1 - Model	2 - W	3 - Driver	4 - Brand Chip	5 - K	6 - Color
07	200	19 - ON-OFF AC220-240V PF >0,9	9 - Smalite	4 - 4000 21661 Lm System 25000 Lm Source 6 - 6000 22744 Lm System 26250 Lm Source	01 Black / Negro / Noir

LED CHIP: SMD 2835 - CRI>80 - L70B10 / 30.000H - 125lm/W (4000K) - RG0



The above information is basic. For updated and more accurate information, please consult Technical Data Sheet on [www.jisoiluminacion.com](http://www.jisoiluminacion.com)  
Consult general issues - [www.jisoiluminacion.com](http://www.jisoiluminacion.com) (Download - Technical Information)



**JISO**  
ILUMINACION  
SPAIN

## High Bay

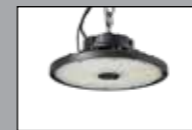

05150-3M P.455



05240-3M P.457



05100 P.461



05150 P.462  
DIMM 0-10V



05150 P.463



05200 P.464  
DIMM 0-10V



05200 P.465



05240 P.467

## Accessories



DC05-SENSOR P.458



DCPROTECTOR-150 P.459



PCREFLECTOR-150 P.459



DC05 P.468



DCP05 P.468



DC05-DALI P.469



CONECIP67103 P.469

## 1 Features High Bay



### Technical improvements in driver

Flicker reduction from <1 to <0,5%  
Higher efficiency from <93 to <94,5%  
Improved output protections to reduce the risk of PCB damage



### Warranty

Professional product  
Great reliability

### Immediate service

Immediate delivery



### Security

Overheating protection  
6KV overvoltage protection  
Short-circuit protection

### Openign

All models available in 120°, 90° and 60°

### Dimmables options

0-10V adjustable high bays in 150W and 200W  
05200 high bay with plus presence sensor DALI converter



### Accessories

Optica  
Seat/Bridge to hold hood  
0-10V to DALI converter

### Complete range

Colour temperature 4000K and 6000K  
Powers 100W, 150W, 200W and 240W



# INDUSTRIAL

High Bay | Light Integrated LED

Switch CCT  
Multipower  
On/Off & 0-10V  
High Efficiency 174 lm/w



3000K

4000K

5000K



100W

3000K - 14225 lm  
4000K - 15387 lm  
5000K - 15188 lm

120W

3000K - 16613 lm  
4000K - 18070 lm  
5000K - 17853 lm

150W

3000K - 20670 lm  
4000K - 22444 lm  
5000K - 21666 lm

# INDUSTRIAL

Light Integrated LED | High Bay

05150-3M90

Campana Industrial LED  
Industrial LED High bay  
Suspension Tertaire LED

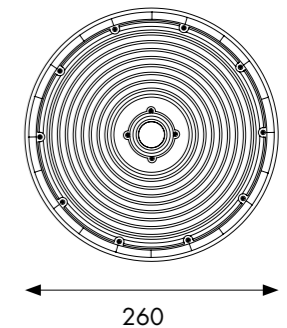
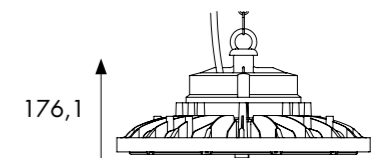

05 150 - 3M 90 - 01

1 2 3 4 5 6

1 - Model	2 - W	3 - Driver	4 - Brand Chip	5 - K	6 - Color
05	100 120 150	3M - 0-10V AC220-240V PF >0,9	9 - Lumileds	0 - CCT Switch ■ 3000 20670 Lm System 26100 Lm Source ■ 4000 22444 Lm System 26100 Lm Source ■ 5000 21666 Lm System 26100 Lm Source	01 Black / Negro / Noir

▼ Accessories not included

- Sensor
- DC05-SENSOR
- Protector
- DCPROTECTOR-150
- Reflector
- DCREFLECTOR-150
- Connector
- CONECIP67103
- DALI-PWM Converter
- DC05DALI

LED CHIP: SMD 2835 - CRI>80 - L70B10 / 50.000H - 174lm/W (4000K) - RG1



The above information is basic. For updated and more accurate information, please consult Technical Data Sheet on [www.jisoiluminacion.com](http://www.jisoiluminacion.com)  
Consult general issues - [www.jisoiluminacion.com](http://www.jisoiluminacion.com) (Download - Technical Information)

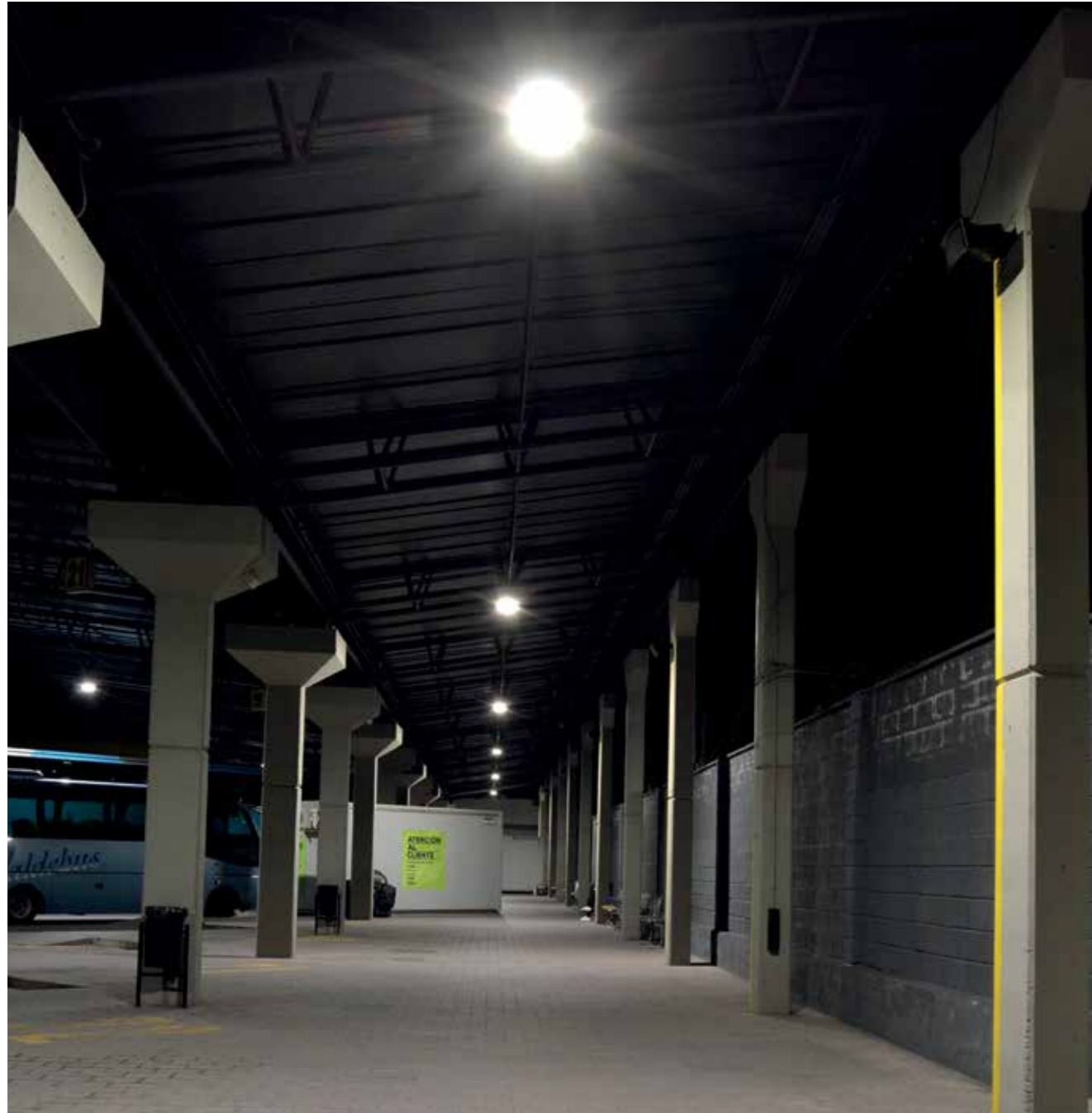

05240-3M90

Campana Industrial LED  
Industrial LED High bay  
Suspension Tertaire LED

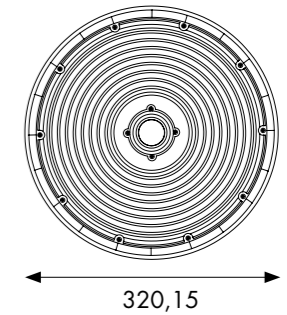
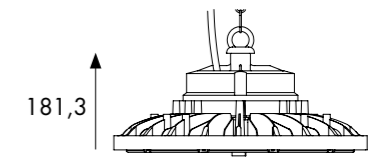

05 240 - 3M 90 - 01

1 - Model	2 - W	3 - Driver	4 - Brand Chip	5 - K	6 - Color	▼ Accessories not included
05	150 200 240	3M - 0-10V AC220-240V PF >0,9	9 - Lumileds	0 - CCT Switch ■ 3000 33379 Lm System 41760 Lm Source ■ 4000 36421 Lm System 41760 Lm Source ■ 5000 35484 Lm System 41760 Lm Source	01 Black / Negro / Noir	Sensor DC05-SENSOR Connector CONECIP67103 DALI-PWM Converter DC05DALI

LED CHIP: SMD 2835 - CRI>80 - L70B10 / 50.000H - 174lm/W (4000K) - RG1



The above information is basic. For updated and more accurate information, please consult Technical Data Sheet on [www.jisoiluminacion.com](http://www.jisoiluminacion.com)  
Consult general issues - [www.jisoiluminacion.com](http://www.jisoiluminacion.com) (Download - Technical Information)



150W

3000K - 23099 lm  
4000K - 24808 lm  
5000K - 24889 lm



200W

3000K - 29176 lm  
4000K - 31701 lm  
5000K - 31097 lm



240W

3000K - 33379 lm  
4000K - 36421 lm  
5000K - 35484 lm

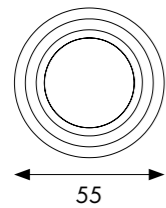
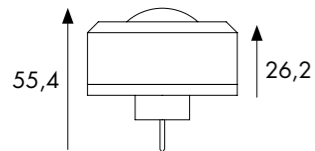

### DC05-SENSOR

Sensor de movimiento para Ref. 05150-3M y 05240-3M  
 Motion sensor for Ref. 05150-3M and 05240-3M  
 Détecteur de mouvement pour Ref. 05150-3M et 05240-3M

Control: Dimmable 0-10V  
 Power supply: 12V-24V DC, >30mA  
 Detection radius: 20%/50%/75%/100% (1-8m)  
 Mounting height: Max 40ft.(12meters)  
 Time setting: 10s/1min/5min/10min/15min/20min/30min/60min  
 Temperature: -4°F ± 140°F (-20°C ± 60°C)

Mando Ref. DC05-MANDO



### DCPROTECTOR-1 50

Protector para Ref. 05150-3M90  
 Protector for Ref. 05150-3M90  
 Protecteur pour Ref. 05150-3M90

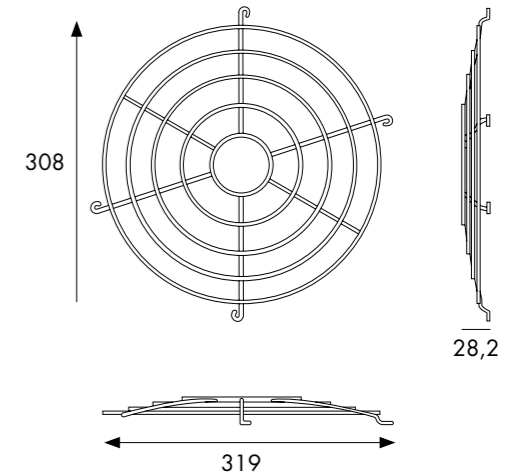

### DCREFLECTOR-1 50

Reflector para Ref. 05150-3M90  
 Reflector for Ref. 05150-3M90  
 Réflecteur pour Réf. 05150-3M90



The above information is basic. For updated and more accurate information, please consult Technical Data Sheet on [www.jisoiluminacion.com](http://www.jisoiluminacion.com)

The above information is basic. For updated and more accurate information, please consult Technical Data Sheet on [www.jisoiluminacion.com](http://www.jisoiluminacion.com)



# INDUSTRIAL

Light Integrated LED | High Bay

## 05100

Campana Industrial LED  
Industrial LED High bay  
Suspension Tertaire LED

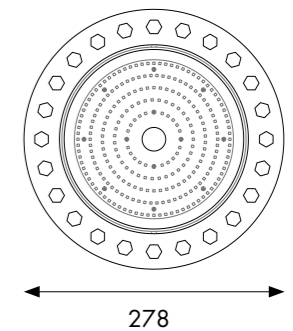
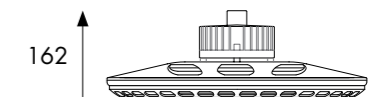

▼ Accessories not included

		- Degree	
Included	Optional	Optional	Optional
120°	R00 - 90°	E00 - 60°	
Connector			
		CONECIP67103	
Support			
		DCP0515001	
Optics			
		DC05100-60	
		DC05100-90	
		DC05100-120	

## 05 100 - 18 8 4 - 01

1 - Model	2 - W	3 - Driver	4 - Brand Chip	5 - K	6 - Color
05	100	18 - ON-OFF AC220-240V PF >0,95	8 - Sanan	4 - ■ 4000 12900 Lm System 13500 Lm Source 6 - ■ 6000 13500 Lm System 14500 Lm Source	01 Black / Negro / Noir

LED CHIP: SMD 3030 - CRI>80 - L70B10 / 35.000H - 135lm/W (4000K) - RG0



The above information is basic. For updated and more accurate information, please consult Technical Data Sheet on [www.jisoiluminacion.com](http://www.jisoiluminacion.com)  
Consult general issues - [www.jisoiluminacion.com](http://www.jisoiluminacion.com) (Download - Technical Information)



# INDUSTRIAL

High Bay | Light Integrated LED

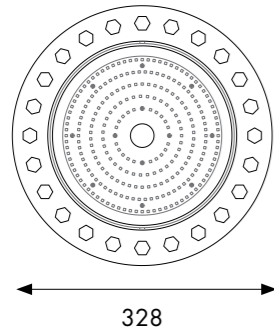
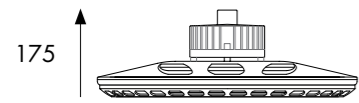

05150-38

Campana Industrial LED Dimmable  
Industrial LED High bay Dimmable  
Suspension Tertiaire LED Dimmable

05 150 - 38 8 4 - 01

1 - Model	2 - W	3 - Driver	4 - Brand Chip	5 - K	6 - Color
05	150	38 - 0-10v AC220-240V PF >0,95	8 - Sanan	4 - 4000 19120 Lm System 20250 Lm Source	01 Black / Negro / Noir

LED CHIP: SMD 3030 - CRI>80 - L70B10 / 35.000H - 135lm/W (4000K) - RG0



The above information is basic. For updated and more accurate information, please consult Technical Data Sheet on [www.jisoiluminacion.com](http://www.jisoiluminacion.com)  
Consult general issues - [www.jisoiluminacion.com](http://www.jisoiluminacion.com) (Download - Technical Information)

▼ Accessories not included

Included	Optional	Optional
120°	R00 - 90°	E00 - 60°
Connector		
CONECIP67103		
Support		
DCP05150-01		
Optics		
DC05150-60		
DC05150-90		
DC05150-120		
DALI-PWM Converter		
DC05DALI		

# INDUSTRIAL

Light Integrated LED | High Bay

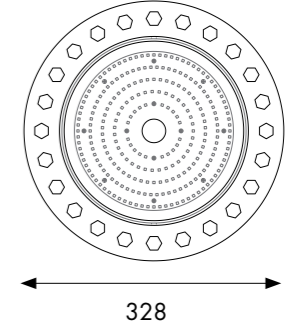
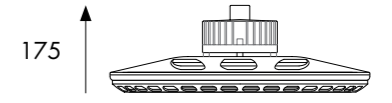

05150

Campana Industrial LED  
Industrial LED High bay  
Suspension Tertiaire LED



05 150 - 18 8 4 - 01

1 - Model	2 - W	3 - Driver	4 - Brand Chip	5 - K	6 - Color
05	150	18 - ON-OFF AC220-240V PF >0,95	8 - Sanan	4 - 4000 19120 Lm System 20250 Lm Source 6 - 6000 20073 Lm System 21000 Lm Source	01 Black / Negro / Noir

LED CHIP: SMD 3030 - CRI>80 - L70B10 / 35.000H - 135lm/W (4000K) - RG0



The above information is basic. For updated and more accurate information, please consult Technical Data Sheet on [www.jisoiluminacion.com](http://www.jisoiluminacion.com)  
Consult general issues - [www.jisoiluminacion.com](http://www.jisoiluminacion.com) (Download - Technical Information)

▼ Accessories not included

Included	Optional	Optional
120°	R00 - 90°	E00 - 60°
Connector		
CONECIP67103		
Support		
DCP05150-01		
Optics		
DC05150-60		
DC05150-90		
DC05150-120		

# INDUSTRIAL

High Bay | Light Integrated LED

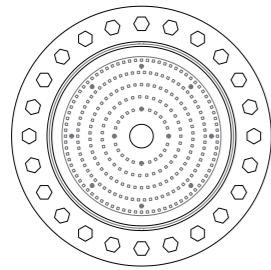
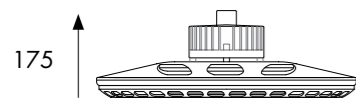

388

05200-38\*

Campana Industrial LED Dimmable  
Industrial LED High bay Dimmable  
Suspension Tertiaire LED Dimmable



05 200 - 38 8 4 - 01

1 - Model	2 - W	3 - Driver	4 - Brand Chip	5 - K	6 - Color
05	200	38 - 0-10v AC220-240V PF >0,95	8 - Sanan	4 - 4000 26183 Lm System 27000 Lm Source	01 Black / Negro / Noir

LED CHIP: SMD 3030 - CRI>80 - L70B10 / 35.000H - 135lm/W (4000K) - RG0



The above information is basic. For updated and more accurate information, please consult Technical Data Sheet on [www.jisoiluminacion.com](http://www.jisoiluminacion.com)  
Consult general issues - [www.jisoiluminacion.com](http://www.jisoiluminacion.com) (Download - Technical Information)

\* Available reference up to the end of stock.

▼ Accessories not included

Included	Optional	Optional
120°	R00 - 90°	E00 - 60°
Connector		
CONECIP67103		
Support		
DCP05240-01		
Optics		
DC05200-60		
DC05200-90		
DC05200-120		
DALI-PWM Converter		
DC05DALI		

# INDUSTRIAL

Light Integrated LED | High Bay

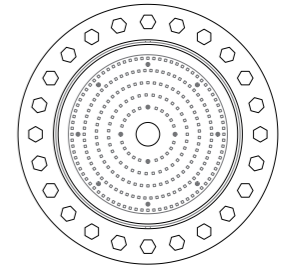
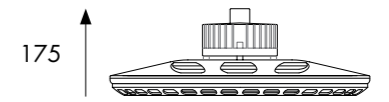

388

05200\*

Campana Industrial LED  
Industrial LED High bay  
Suspension Tertiaire LED

05 200 - 18 8 4 - 01

1 - Model	2 - W	3 - Driver	4 - Brand Chip	5 - K	6 - Color
05	200	18 - ON-OFF AC220-240V PF >0,95	8 - Sanan	4 - 4000 26183 Lm System 27000 Lm Source	01 Black / Negro / Noir

LED CHIP: SMD 3030 - CRI>80 - L70B10 / 35.000H - 135lm/W (4000K) - RG0



The above information is basic. For updated and more accurate information, please consult Technical Data Sheet on [www.jisoiluminacion.com](http://www.jisoiluminacion.com)  
Consult general issues - [www.jisoiluminacion.com](http://www.jisoiluminacion.com) (Download - Technical Information)

\* Available reference up to the end of stock.

▼ Accessories not included

Included	Optional	Optional
120°	R00 - 90°	E00 - 60°
Connector		
CONECIP67103		
Support		
DCP05240-01		
Optics		
DC05200-60		
DC05200-90		
DC05200-120		



05240\*

Campana Industrial LED  
Industrial LED High bay  
Suspension Tertiaire LED

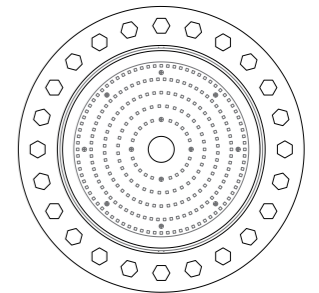
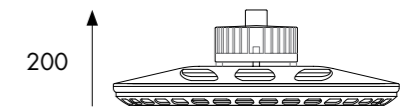

388

▼ Accessories not included

	Included	Optional	Optional
° - Degree	120°	R00 - 90°	E00 - 60°
Connector	CONECIP67103		
Support	DCP05240-01		
Optics	DC05240-60	DC05240-90	DC05240-120

05 240 - 18 8 4 - 01

1 2 3 4 5 6

1 - Model	2 - W	3 - Driver	4 - Brand Chip	5 - K	6 - Color
05	240	18 - ON-OFF AC220-240V PF >0,95	8 - Sanan	4 - 4000 29336 Lm System 32400 Lm Source 6 - 6000 30800 Lm System 33600 Lm Source	01 Black / Negro / Noir

LED CHIP: SMD 3030 - CRI>80 - L70B10 / 35.000H - 135lm/W (4000K) - RG0



The above information is basic. For updated and more accurate information, please consult Technical Data Sheet on [www.jisoiluminacion.com](http://www.jisoiluminacion.com)  
Consult general issues - [www.jisoiluminacion.com](http://www.jisoiluminacion.com) (Download - Technical Information)

\* Available reference up to the end of stock.

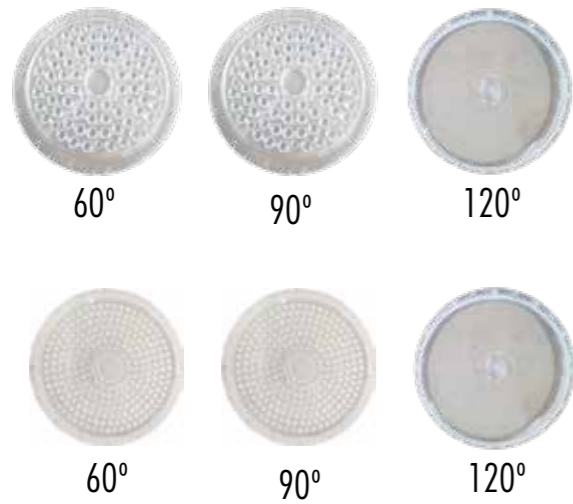

## DC05

Óptica 60°, 90°, 120°  
Optics 60°, 90°, 120°  
Optique 60°, 90°, 120°

Ref,	Accessory for
DC05100-60	05100
DC05100-90	05100
DC05100-120	05100
DC05150-60	05150
DC05150-90	05150
DC05150-120	05150
DC05200-60*	05200
DC05200-90*	05200
DC05200-120*	05200
DC05240-60*	05240
DC05240-90*	05240
DC05240-120*	05240



## DCPO5\*

Soporte  
Support  
Soutien

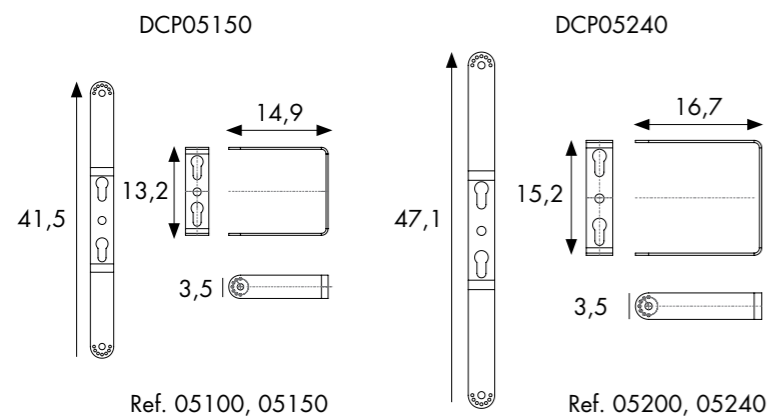

The above information is basic. For updated and more accurate information, please consult Technical Data Sheet on [www.jisoiluminacion.com](http://www.jisoiluminacion.com)

\* Available reference up to the end of stock.

## DC05DALI

Convertor DALI/PWM. Ref. 05150-38 y 05200-38  
DALI/PWM converter for Ref. 05150-38 and 05200-38  
Convertisseur DALI/PWM pour Ref. 05150-38 et 05200-38

Regulation Range: 10%-100%  
Regulation: DALI input/PWM output  
Input Voltage BUS DALI: 10-22.5Vdc  
Size: Ø30x110mm

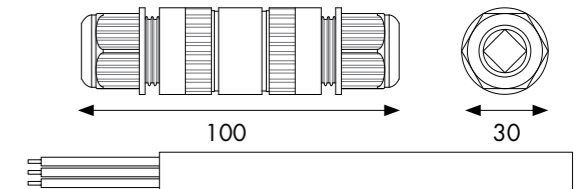

Convertidor de señal, no aislado, que transforma la señal DALI, proveniente de un BUS DALI, en señal PWM y que es compatible con las campanas industriales regulables de la serie 05 de JISO ILUMINACION. El convertor se ajusta al protocolo DALI IEC 62386-101, 102, 103, 207 y, gracias a su grado de protección IP67, siempre que se instale correctamente, confiere protección frente al agua a la conexión que se establece en su interior.

Signal converter, non-isolated, to change DALI signal, from a BUS DALI, into PWM signal. Compatible with industrial High-Bays series 05 from JISO ILUMINACION. It conforms to the DALI protocol IEC 62386-101, 102, 103, 207 and IP 67 rating.

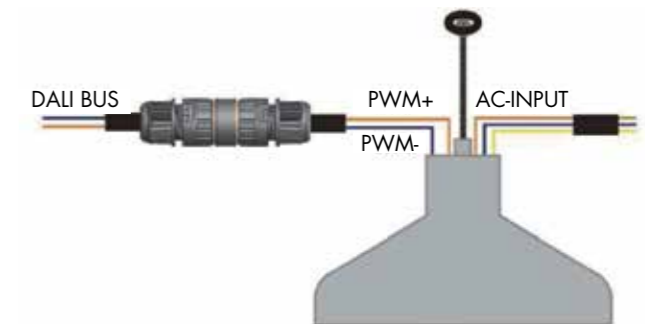

## CONECIP67103

Conector de cable IP67  
Cable connector IP67  
Connecteur de câble IP67

Diametro de cable Ø 7/8,9 mm  
Cable diameter Ø 7/8,9 mm  
Diamètre du câble Ø 7/8,9 mm

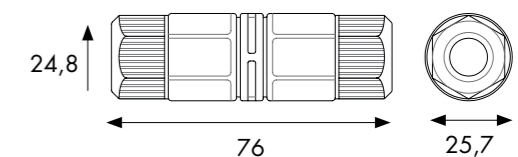

The above information is basic. For updated and more accurate information, please consult Technical Data Sheet on [www.jisoiluminacion.com](http://www.jisoiluminacion.com)

